

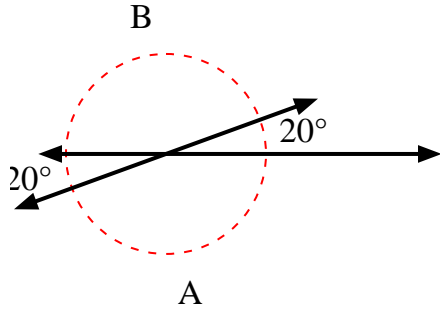

Trova il valore dell'angolo 'A' e dell'angolo 'B'.

1)



2)

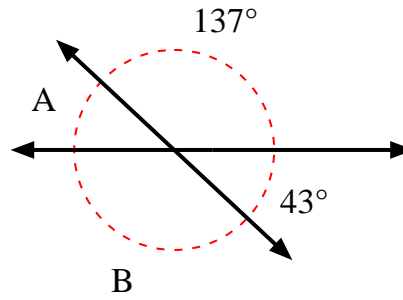

3)

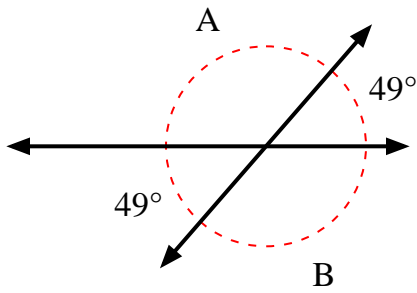

4)

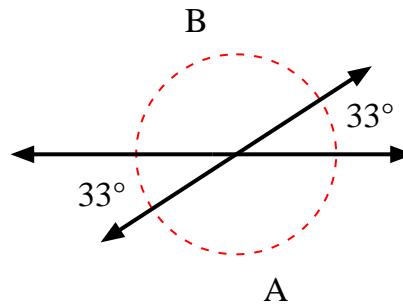

5)

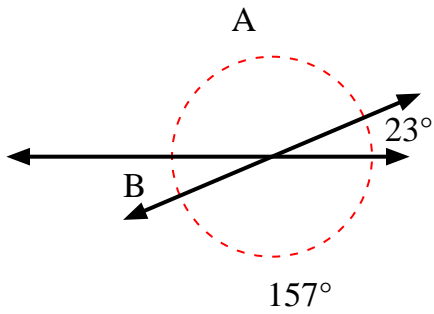

6)

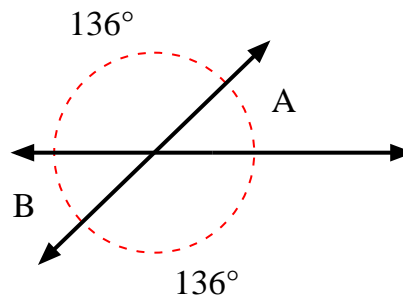

7)

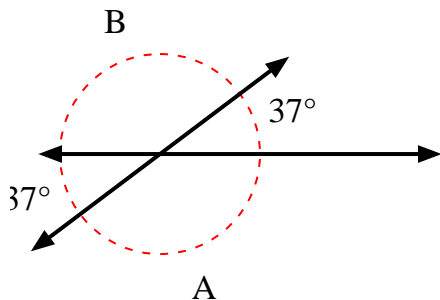

8)

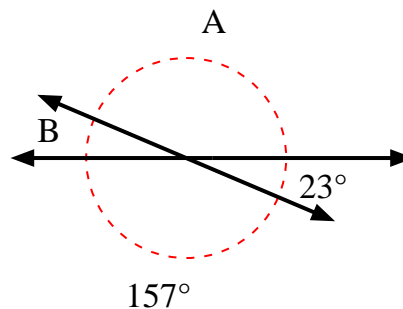

Risposte

1. _____
2. _____
3. _____
4. _____
5. _____
6. _____
7. _____
8. _____



Trova il valore dell'angolo 'A' e dell'angolo 'B'.

1)

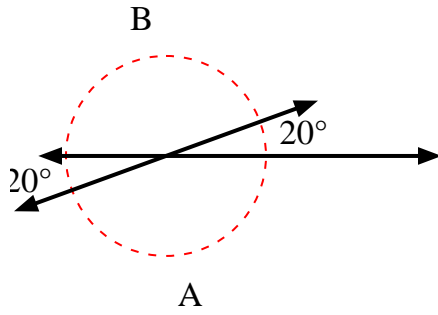

2)

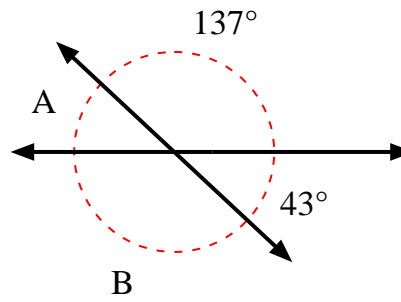

3)

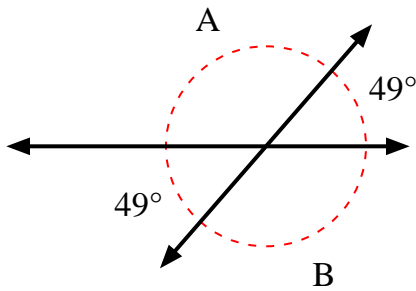

4)

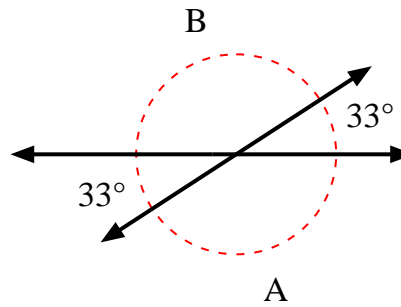

5)

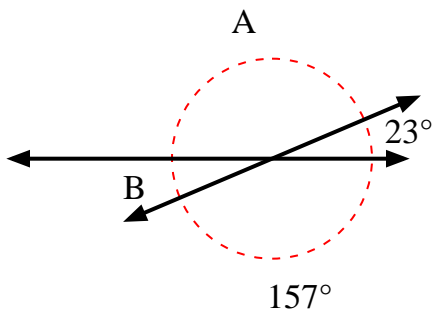

6)

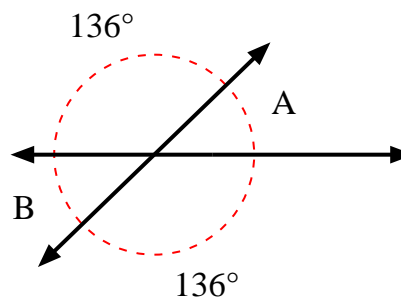

7)

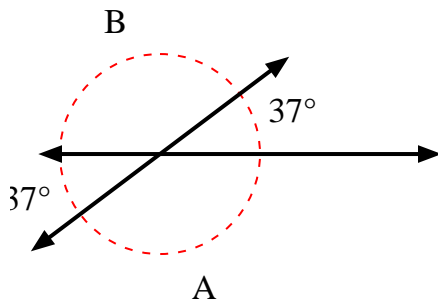

8)

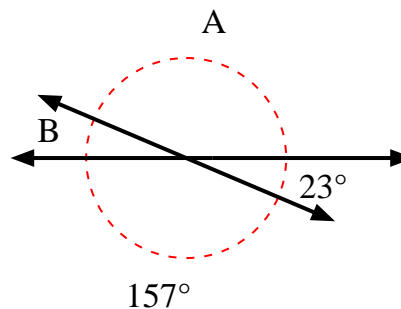
**Risposte**

1.	160°	160°
2.	43°	137°
3.	131°	131°
4.	147°	147°
5.	157°	23°
6.	44°	44°
7.	143°	143°
8.	157°	23°