

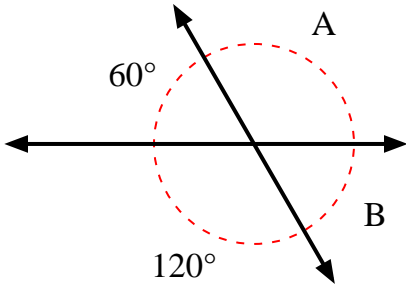

Trova il valore dell'angolo 'A' e dell'angolo 'B'.

1)



2)

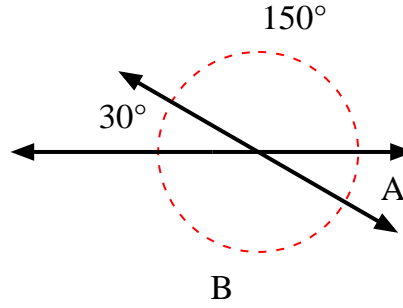

3)

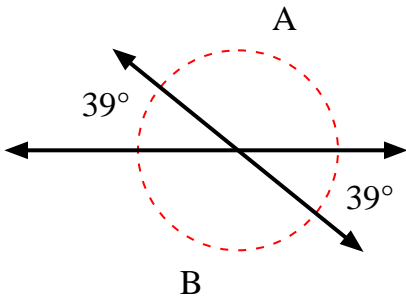

4)

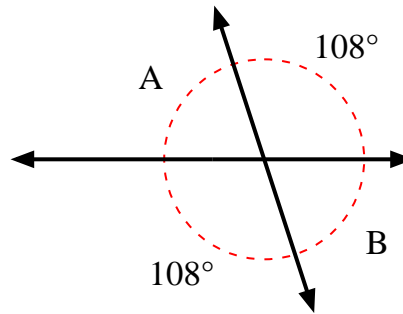

5)

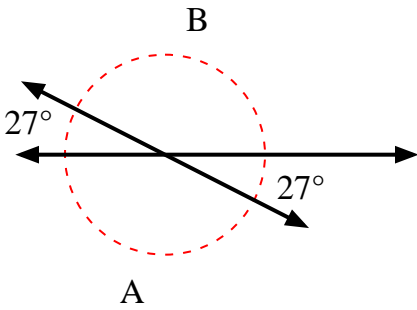

6)

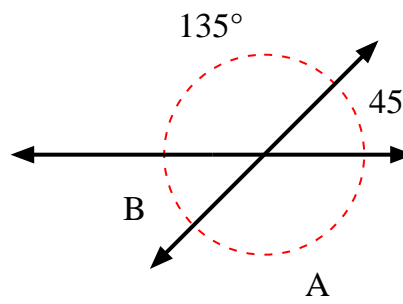

7)

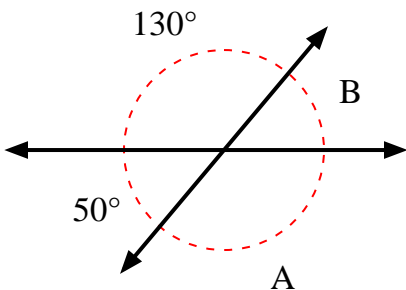

8)

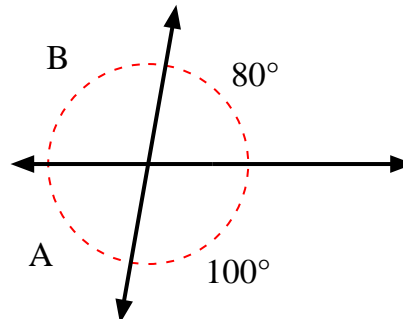

Risposte

1. _____
2. _____
3. _____
4. _____
5. _____
6. _____
7. _____
8. _____



Trova il valore dell'angolo 'A' e dell'angolo 'B'.

1)

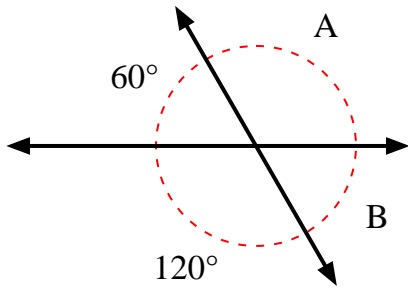

2)

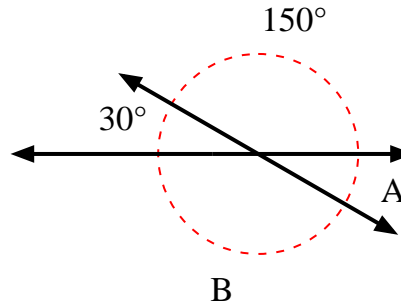

3)

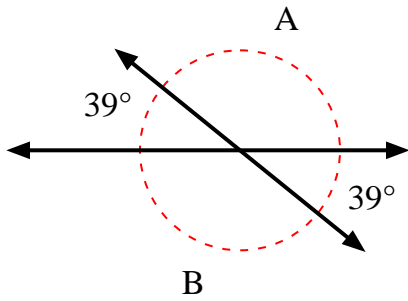

4)

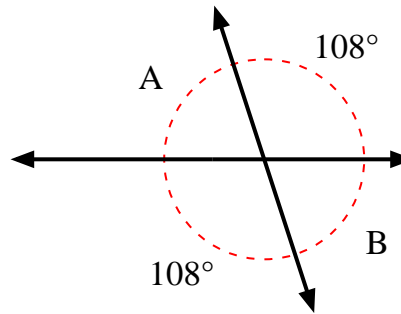

5)

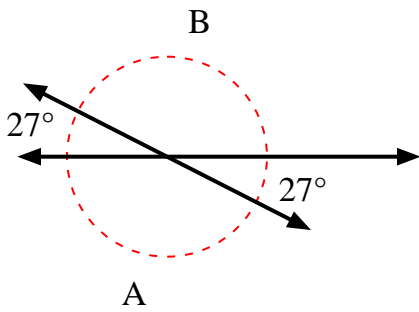

6)

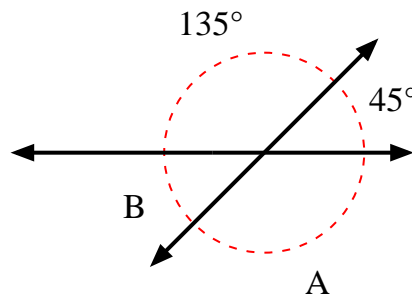

7)

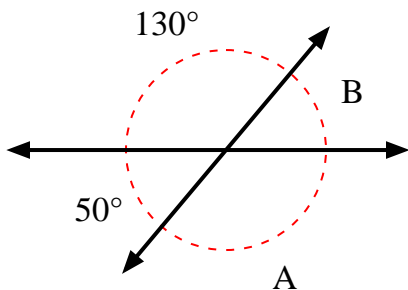

8)

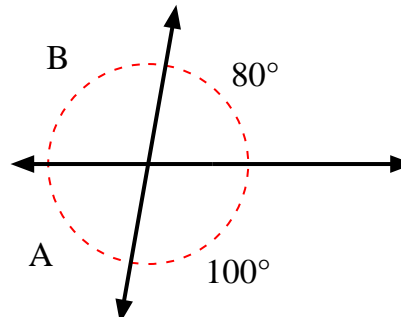
**Risposte**

1.	120°	60°
2.	30°	150°
3.	141°	141°
4.	72°	72°
5.	153°	153°
6.	135°	45°
7.	130°	50°
8.	80°	100°



Trova il valore dell'angolo 'A' e dell'angolo 'B'.

1)

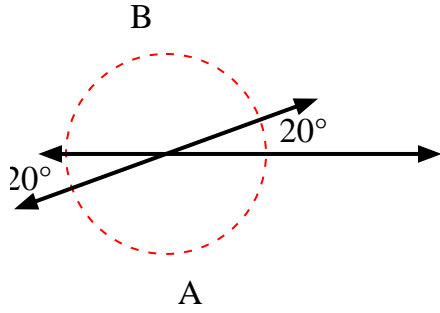

2)

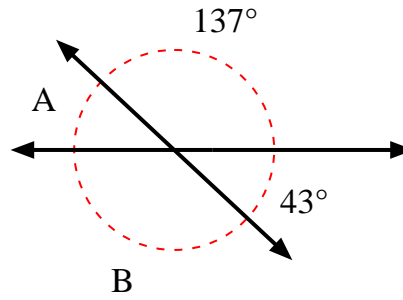

3)

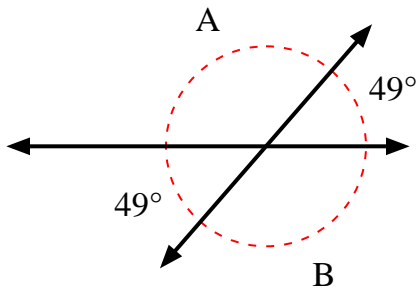

4)

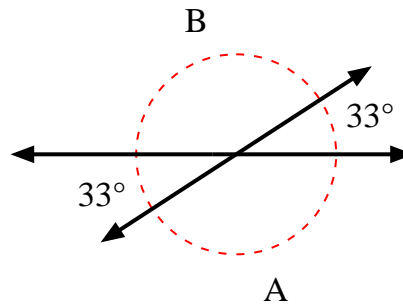

5)

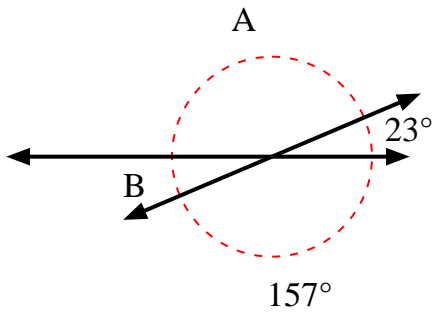

6)

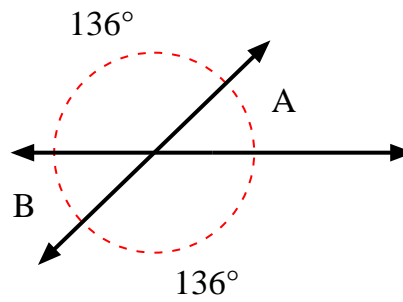

7)

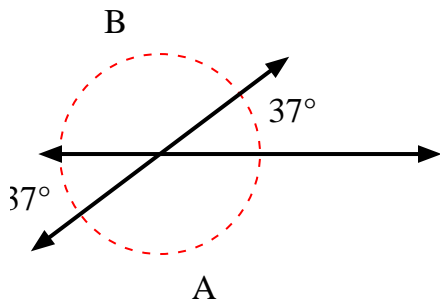

8)

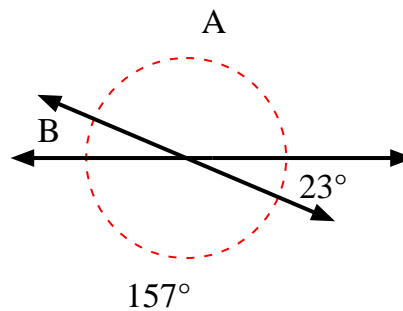

Risposte

1. _____
2. _____
3. _____
4. _____
5. _____
6. _____
7. _____
8. _____



Trova il valore dell'angolo 'A' e dell'angolo 'B'.

1)

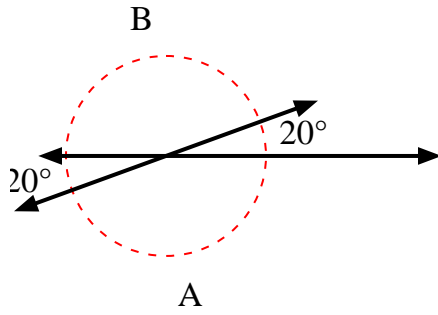

2)

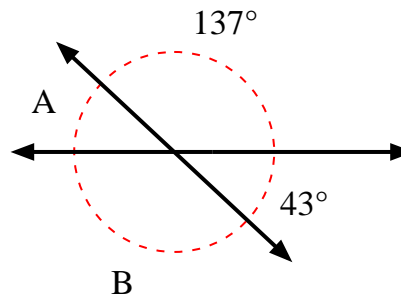

3)

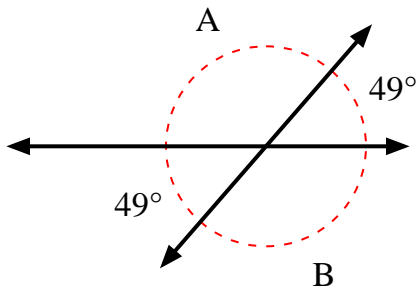

4)

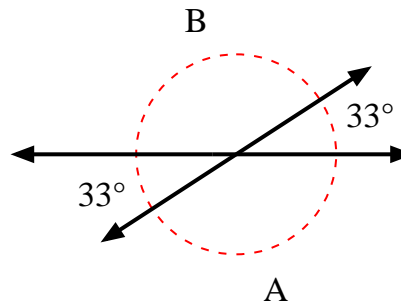

5)

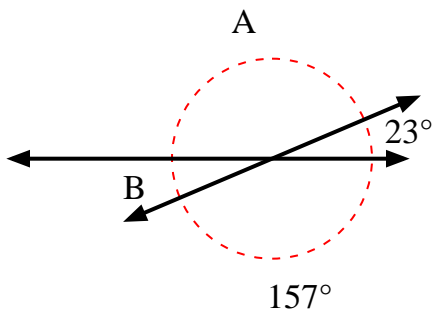

6)

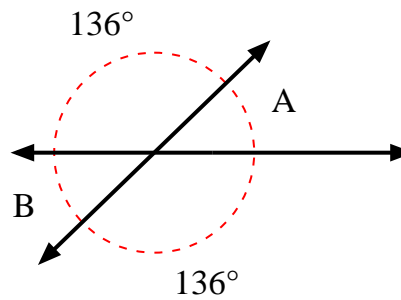

7)

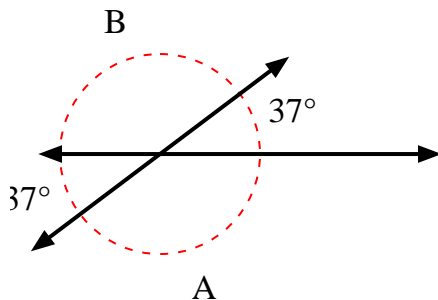

8)

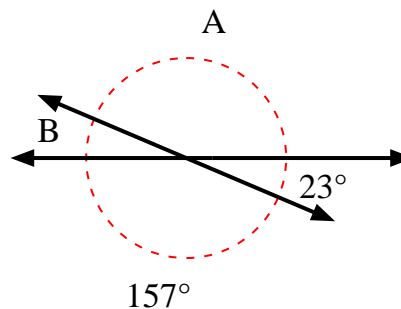
**Risposte**

1.	160°	160°
2.	43°	137°
3.	131°	131°
4.	147°	147°
5.	157°	23°
6.	44°	44°
7.	143°	143°
8.	157°	23°



Trova il valore dell'angolo 'A' e dell'angolo 'B'.

1)

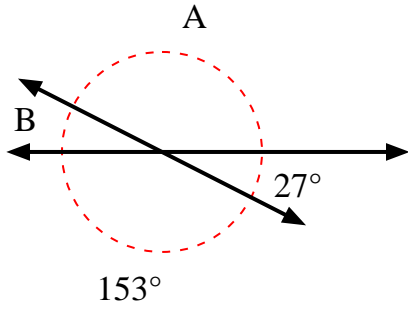

2)

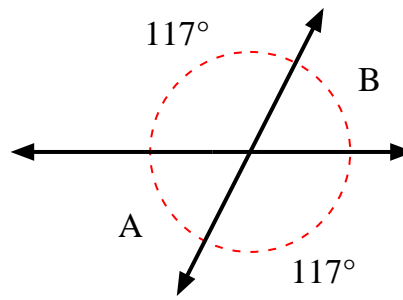

3)

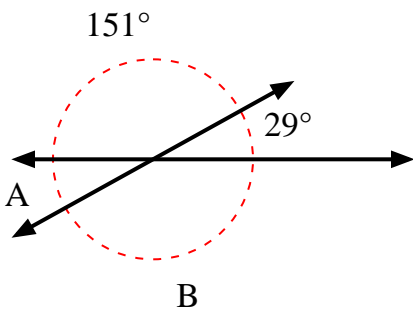

4)

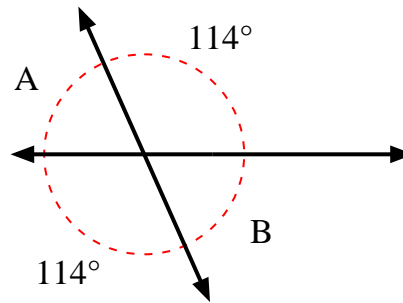

5)

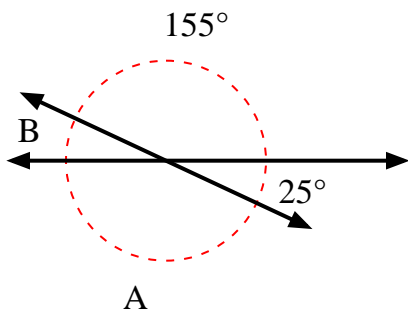

6)

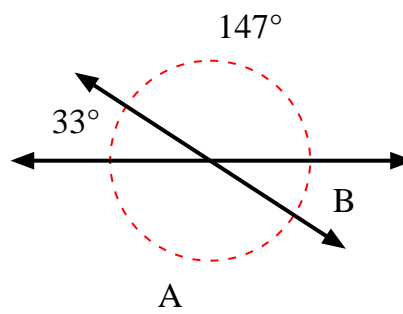

7)

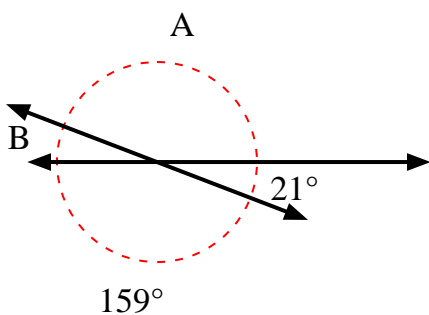

8)

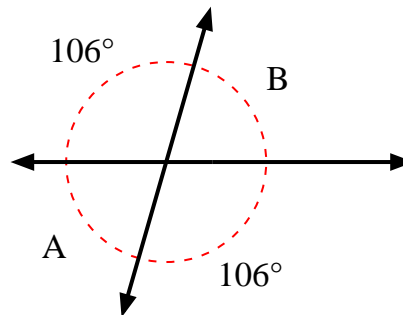

Risposte

1. _____
2. _____
3. _____
4. _____
5. _____
6. _____
7. _____
8. _____



Trova il valore dell'angolo 'A' e dell'angolo 'B'.

1)

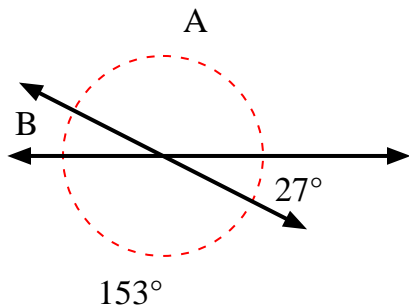

2)

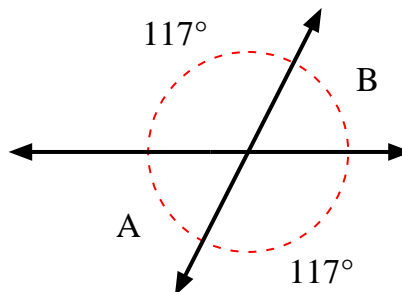

3)

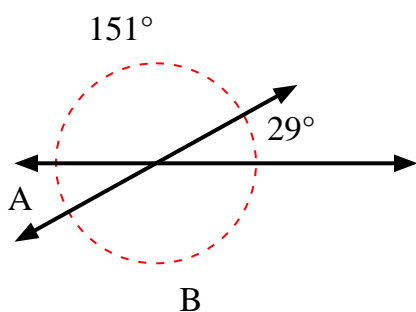

4)

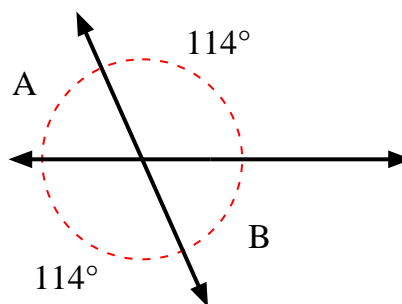

5)

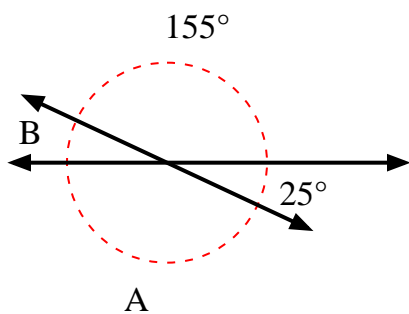

6)

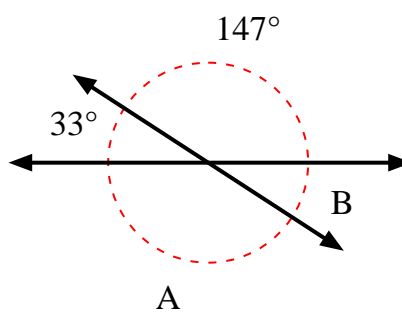

7)

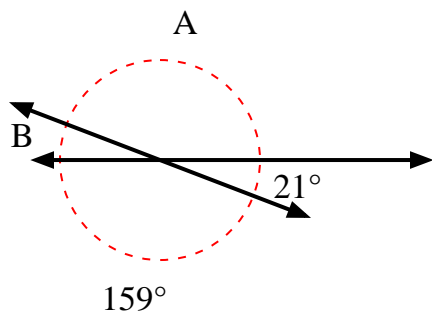

8)

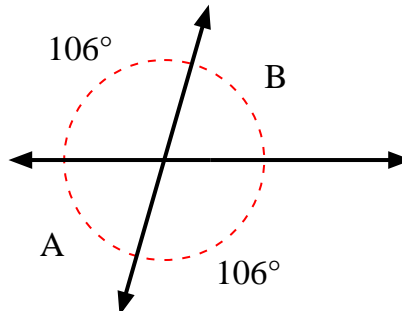
**Risposte**

1.	153°	27°
2.	63°	63°
3.	29°	151°
4.	66°	66°
5.	155°	25°
6.	147°	33°
7.	159°	21°
8.	74°	74°



Trova il valore dell'angolo 'A' e dell'angolo 'B'.

1)

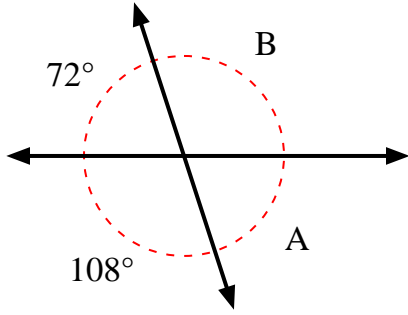

2)

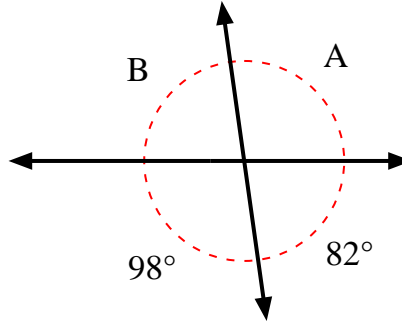

3)

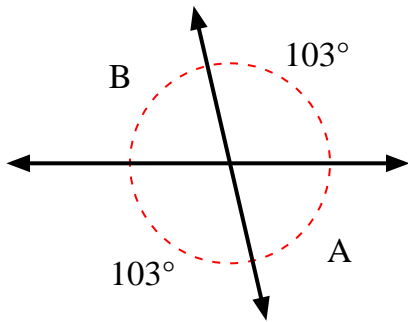

4)

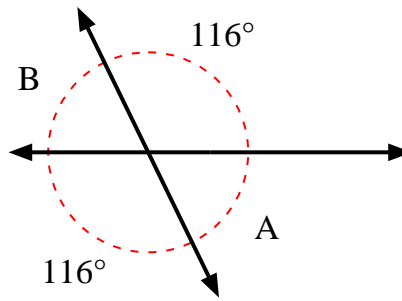

5)

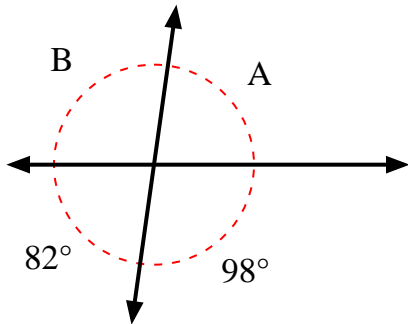

6)

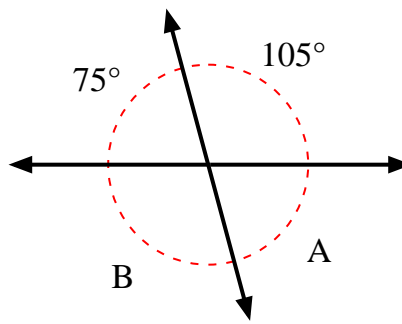

7)

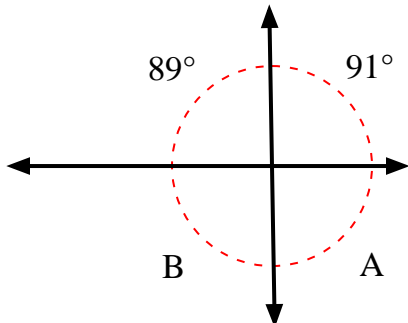

8)

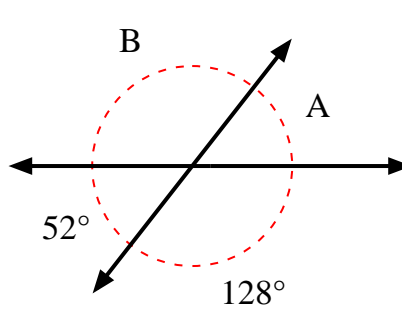

Risposte

1. _____
2. _____
3. _____
4. _____
5. _____
6. _____
7. _____
8. _____



Trova il valore dell'angolo 'A' e dell'angolo 'B'.

1)

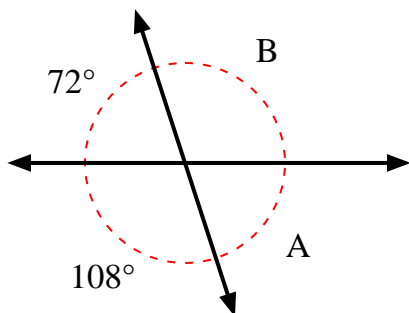

2)

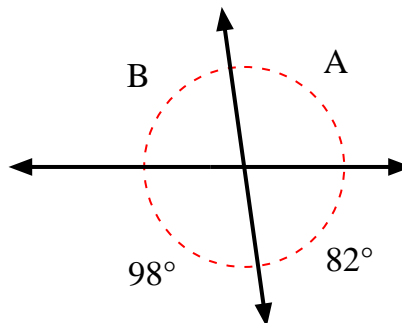

3)

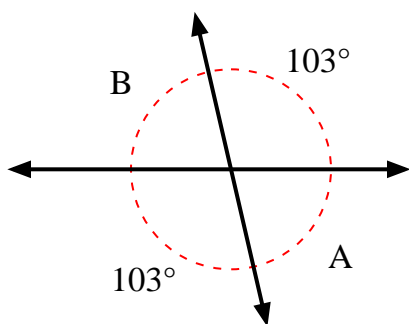

4)

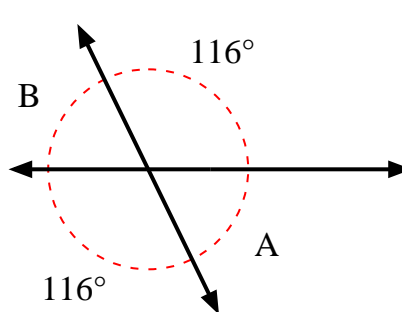

5)

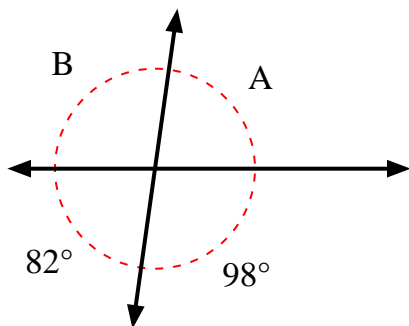

6)

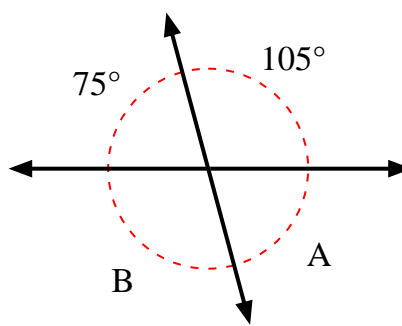

7)

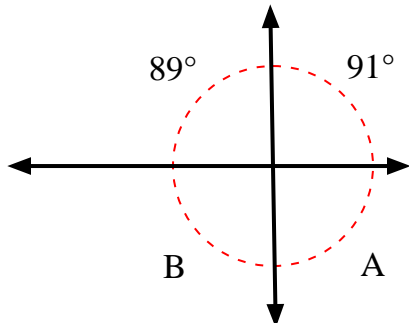

8)

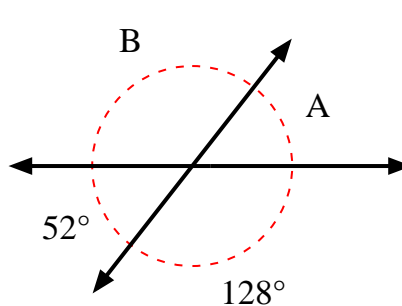
**Risposte**

1.	72°	108°
2.	98°	82°
3.	77°	77°
4.	64°	64°
5.	82°	98°
6.	75°	105°
7.	89°	91°
8.	52°	128°



Trova il valore dell'angolo 'A' e dell'angolo 'B'.

1)

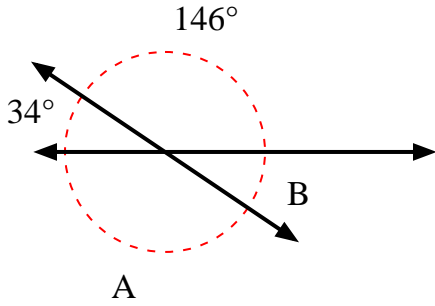

2)

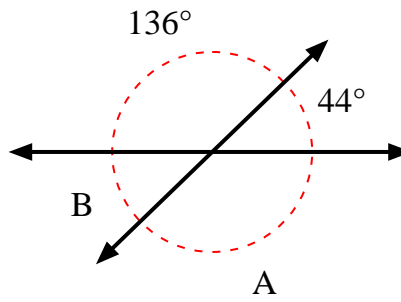

3)

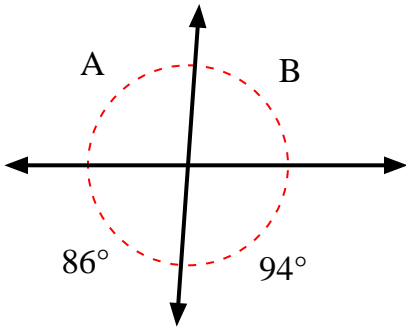

4)

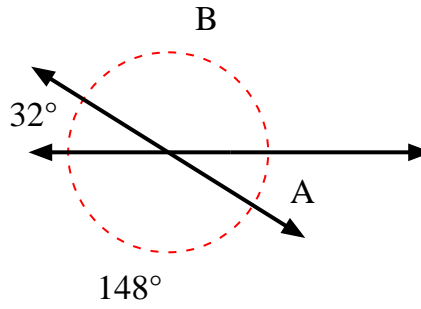

5)

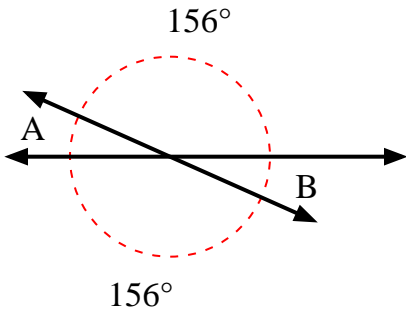

6)

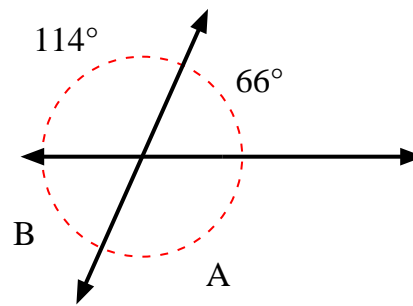

7)

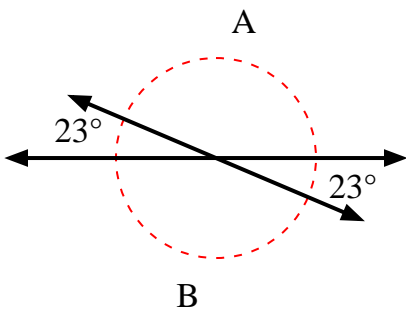

8)

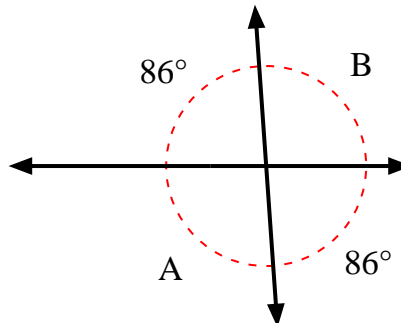

Risposte

1. _____
2. _____
3. _____
4. _____
5. _____
6. _____
7. _____
8. _____



Trova il valore dell'angolo 'A' e dell'angolo 'B'.

1)

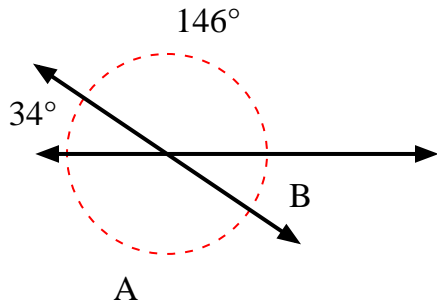

2)

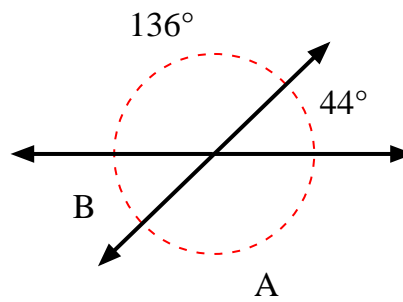

3)

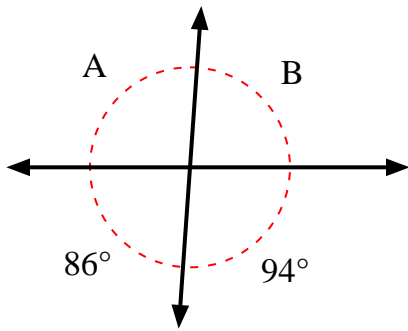

4)

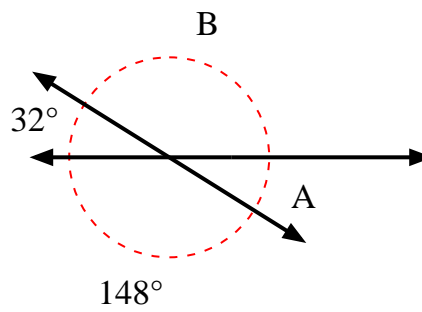

5)

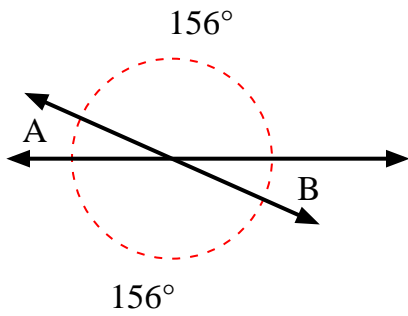

6)

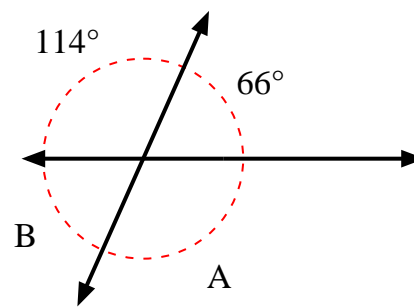

7)

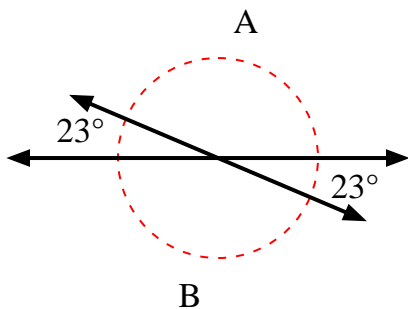

8)

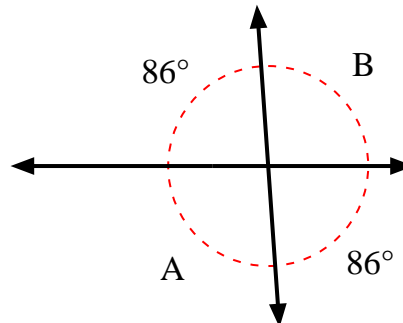
**Risposte**

1.	146°	34°
2.	136°	44°
3.	94°	86°
4.	32°	148°
5.	24°	24°
6.	114°	66°
7.	157°	157°
8.	94°	94°



Trova il valore dell'angolo 'A' e dell'angolo 'B'.

1)

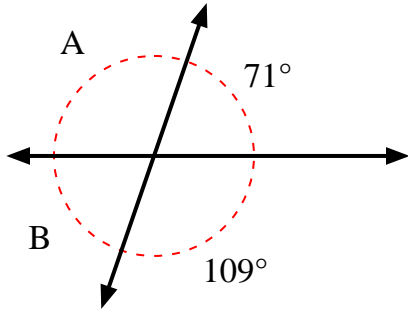

2)

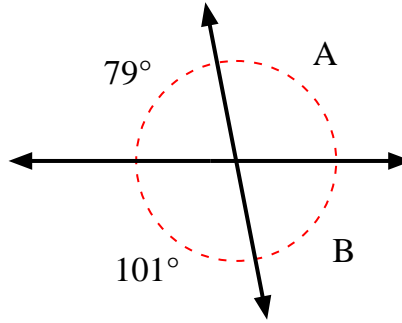

3)

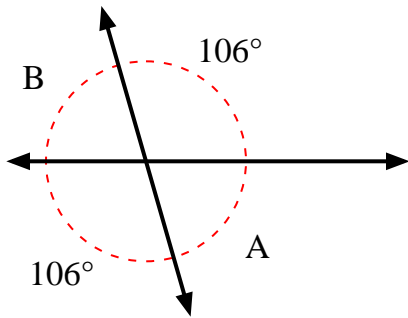

4)

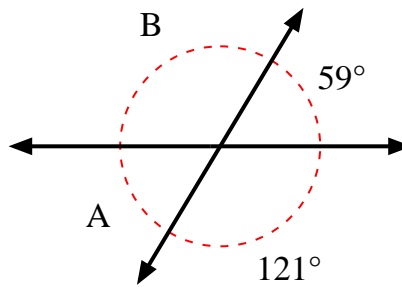

5)

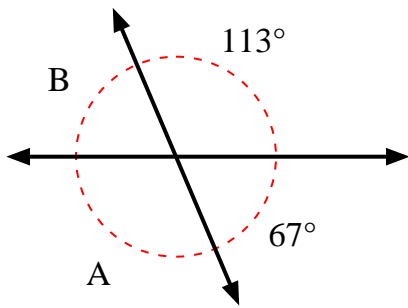

6)

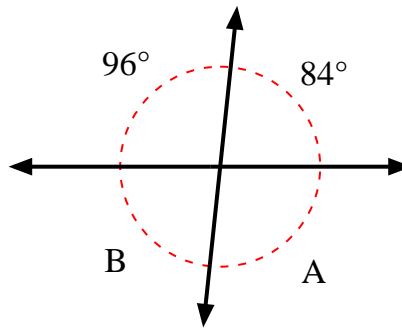

7)

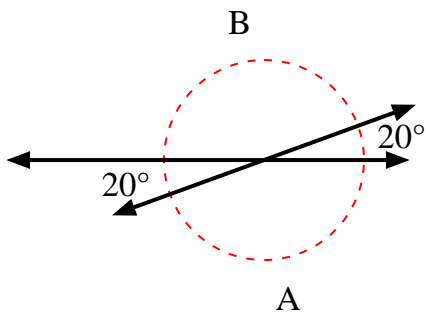

8)

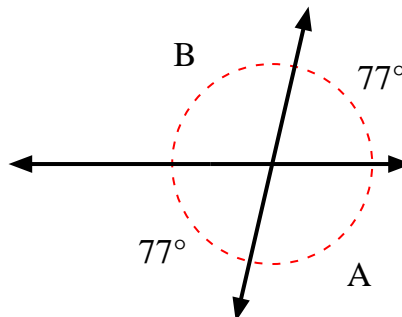

Risposte

1. _____
2. _____
3. _____
4. _____
5. _____
6. _____
7. _____
8. _____



Trova il valore dell'angolo 'A' e dell'angolo 'B'.

1)

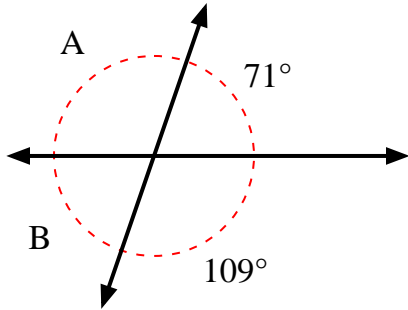

2)

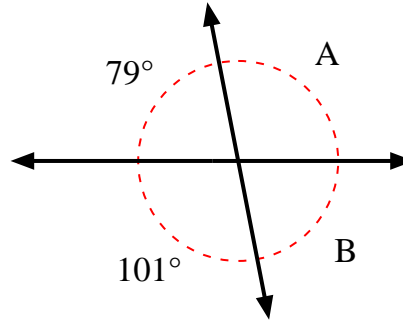

3)

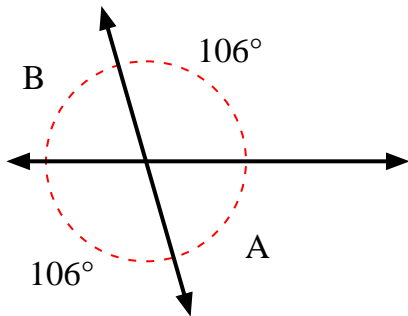

4)

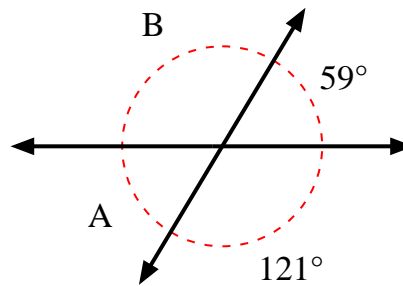

5)

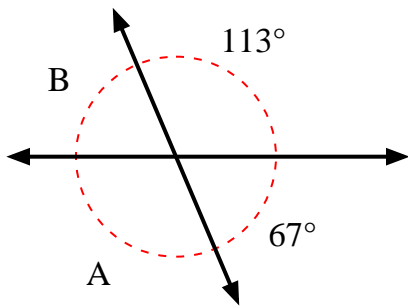

6)

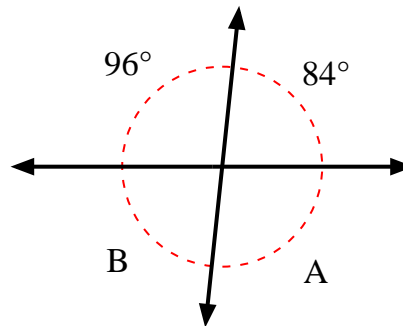

7)

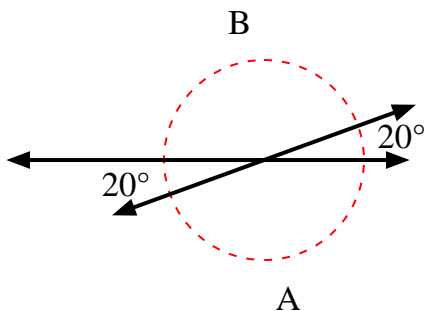

8)

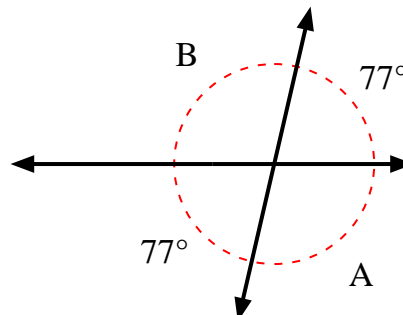
**Risposte**

1.	109°	71°
2.	101°	79°
3.	74°	74°
4.	59°	121°
5.	113°	67°
6.	96°	84°
7.	160°	160°
8.	103°	103°



Trova il valore dell'angolo 'A' e dell'angolo 'B'.

1)

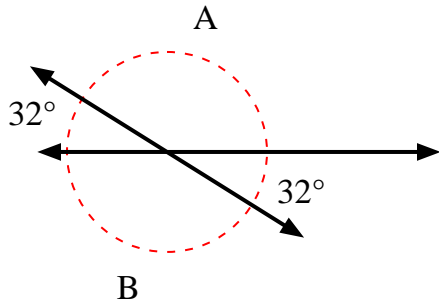

2)

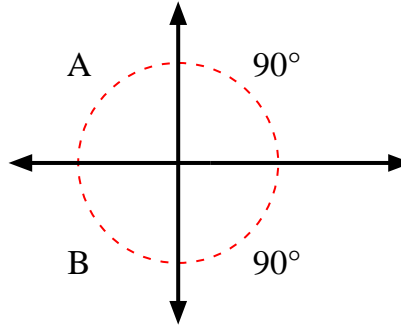

3)

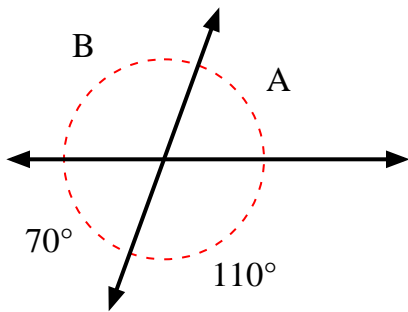

4)

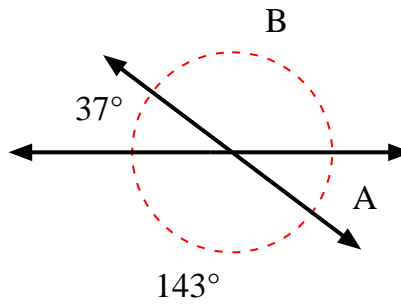

5)

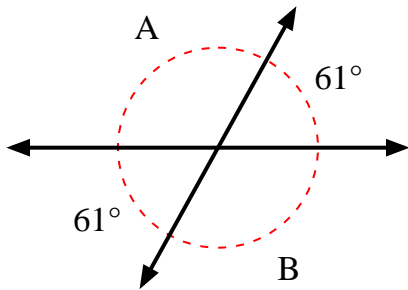

6)

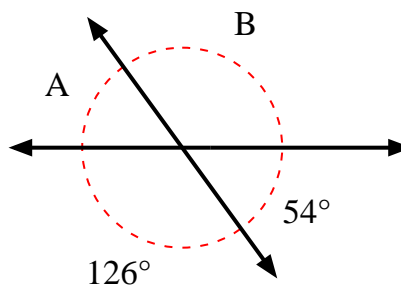

7)

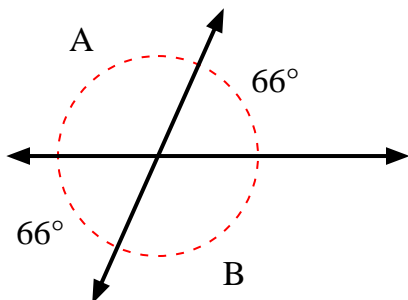

8)

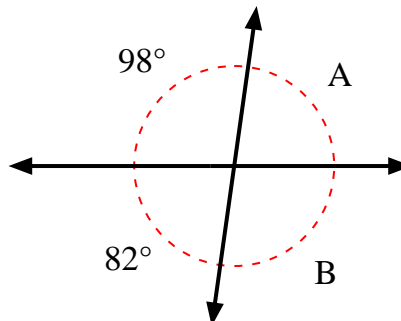

Risposte

1. _____
2. _____
3. _____
4. _____
5. _____
6. _____
7. _____
8. _____



Trova il valore dell'angolo 'A' e dell'angolo 'B'.

1)

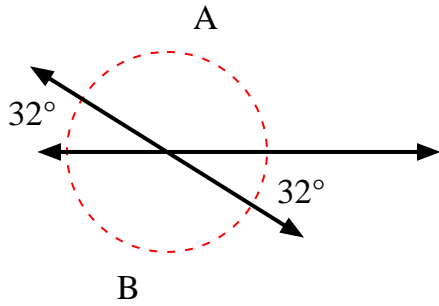

2)

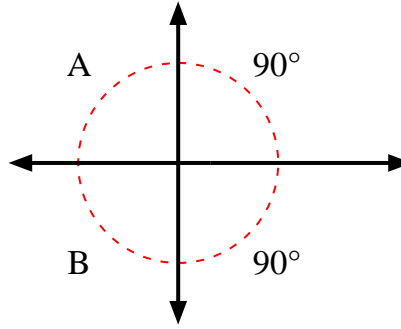

3)

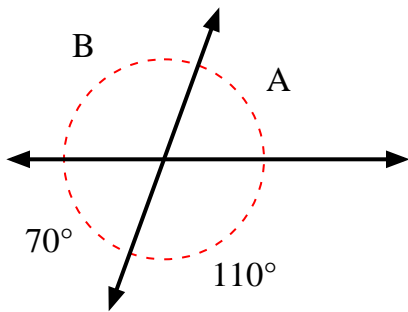

4)

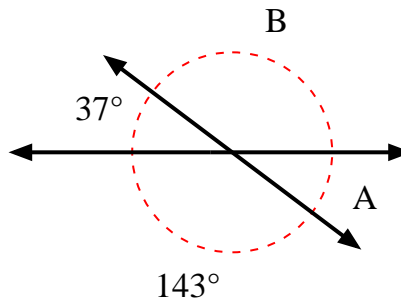

5)

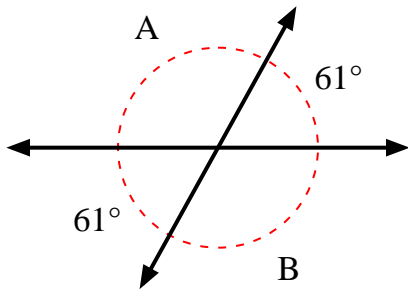

6)

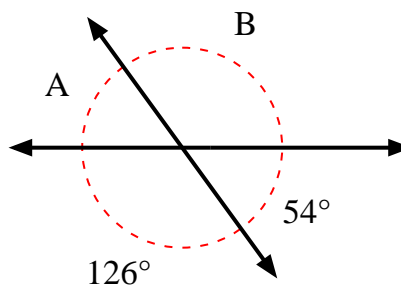

7)

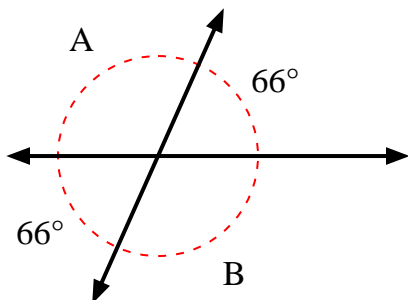

8)

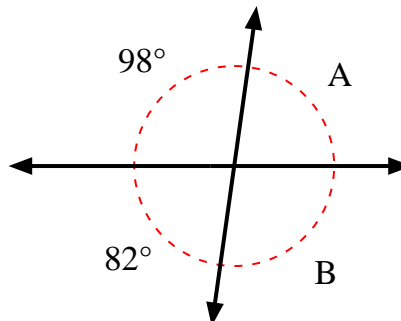
**Risposte**

1.	148°	148°
2.	90°	90°
3.	70°	110°
4.	37°	143°
5.	119°	119°
6.	54°	126°
7.	114°	114°
8.	82°	98°



Trova il valore dell'angolo 'A' e dell'angolo 'B'.

1)

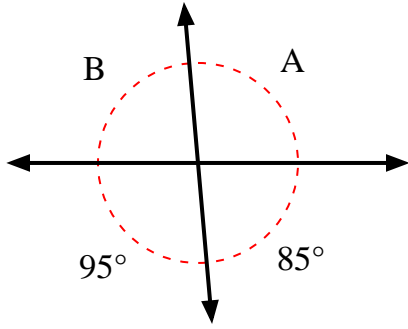

2)

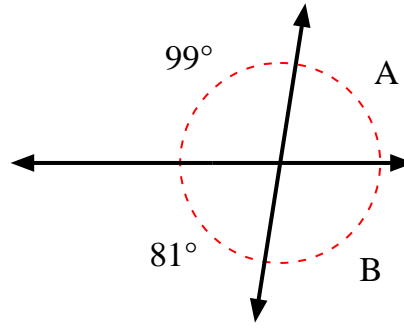

3)

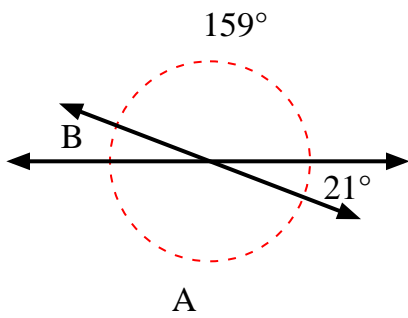

4)

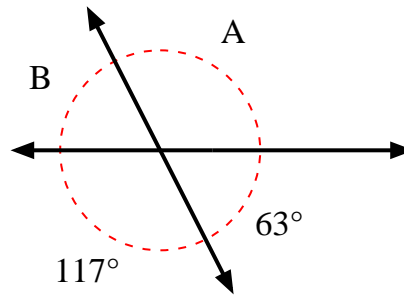

5)

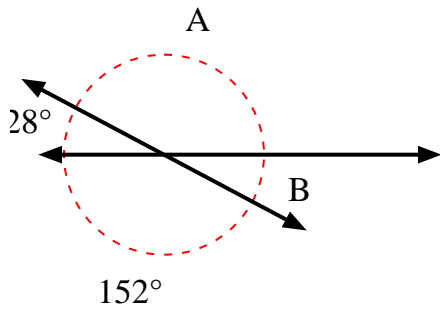

6)

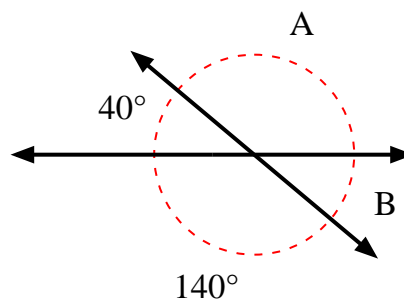

7)

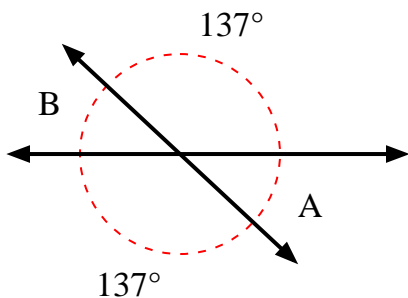

8)

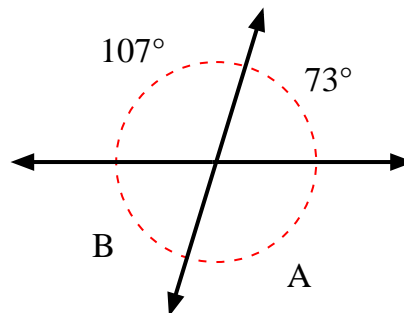

Risposte

1. _____
2. _____
3. _____
4. _____
5. _____
6. _____
7. _____
8. _____



Trova il valore dell'angolo 'A' e dell'angolo 'B'.

1)

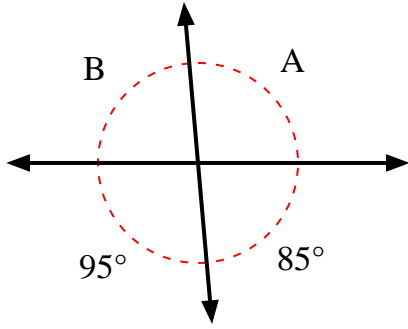

2)

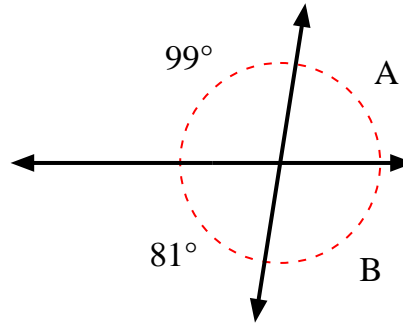

3)

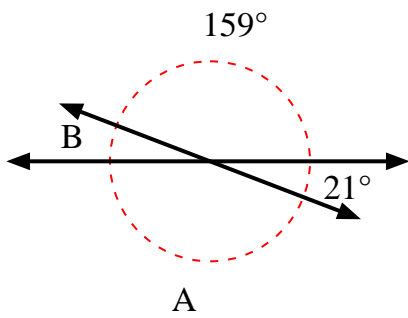

4)

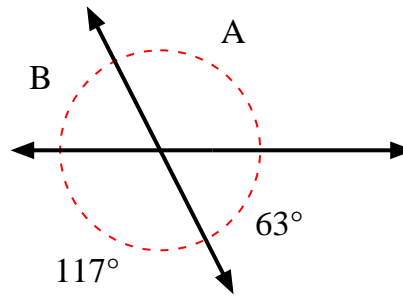

5)

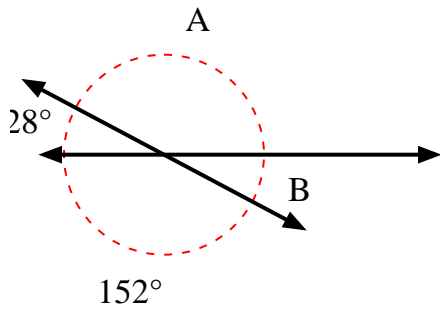

6)

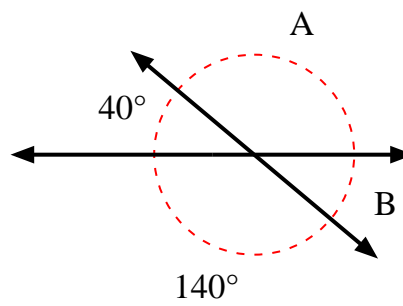

7)

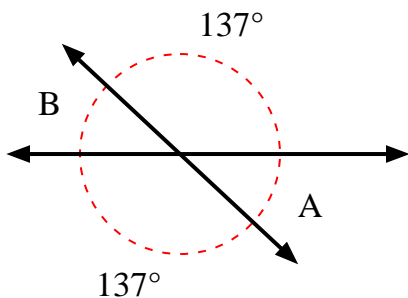

8)

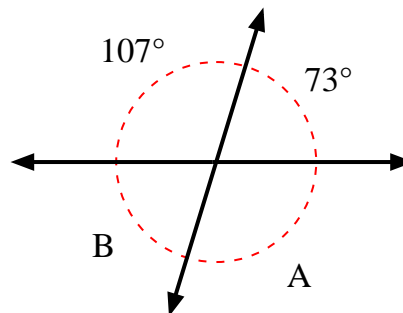
**Risposte**

1.	95°	85°
2.	81°	99°
3.	159°	21°
4.	117°	63°
5.	152°	28°
6.	140°	40°
7.	43°	43°
8.	107°	73°



Trova il valore dell'angolo 'A' e dell'angolo 'B'.

1)

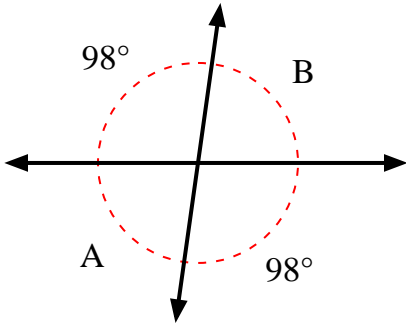

2)

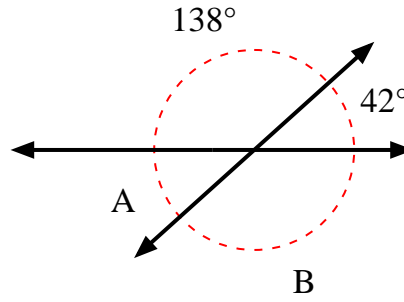

3)

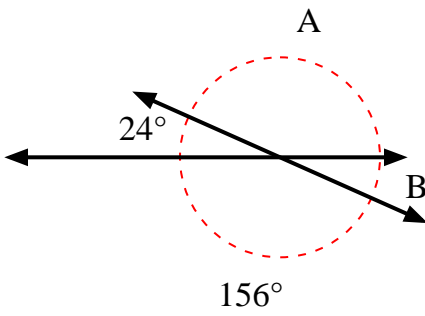

4)

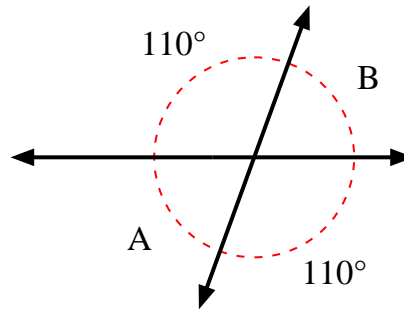

5)

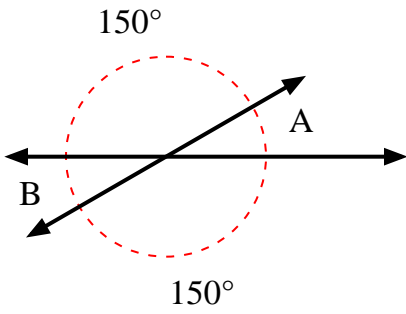

6)

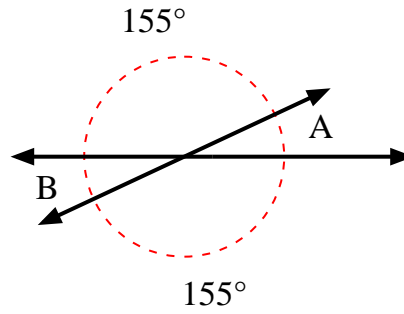

7)

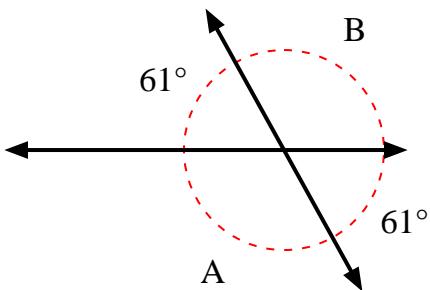

8)

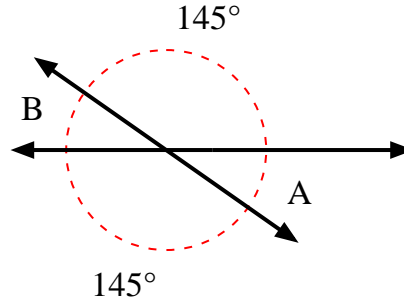

Risposte

1. _____
2. _____
3. _____
4. _____
5. _____
6. _____
7. _____
8. _____



Trova il valore dell'angolo 'A' e dell'angolo 'B'.

1)

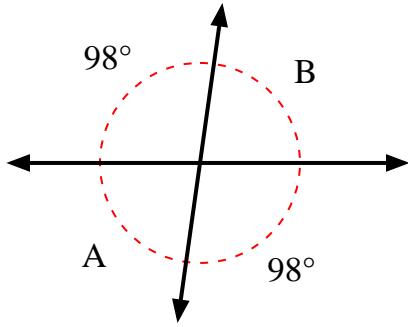

2)

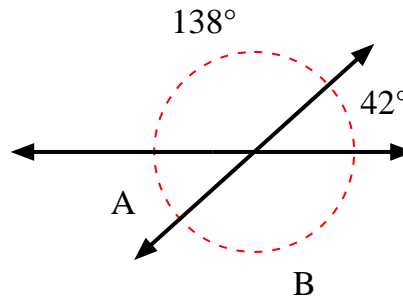

3)

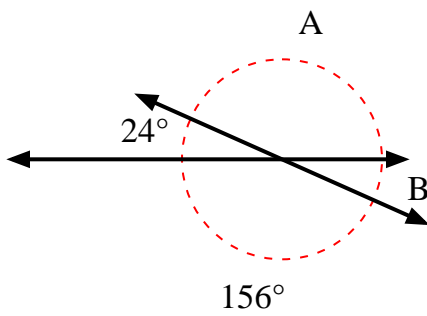

4)

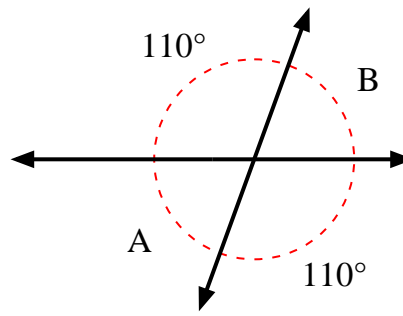

5)

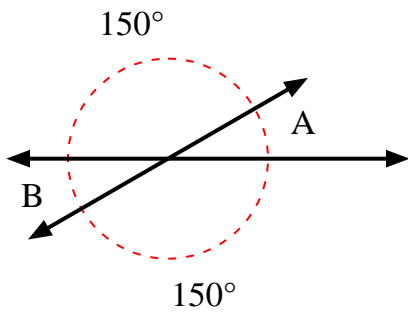

6)

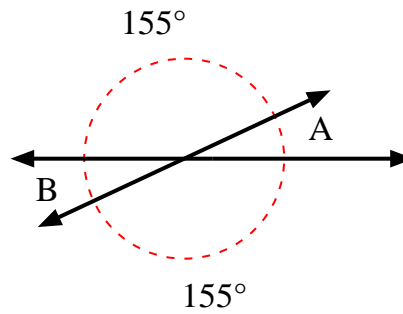

7)

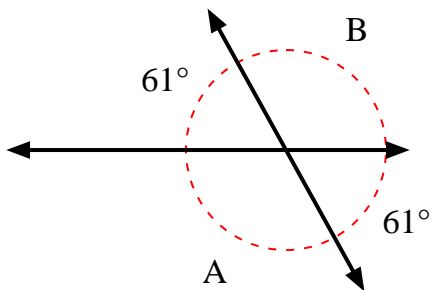

8)

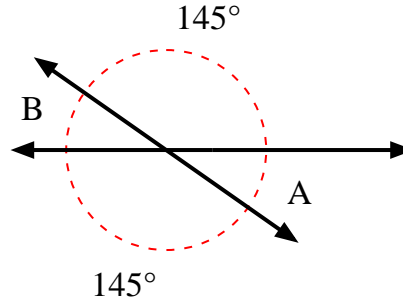
**Risposte**

1.	82°	82°
2.	42°	138°
3.	156°	24°
4.	70°	70°
5.	30°	30°
6.	25°	25°
7.	119°	119°
8.	35°	35°



Trova il valore dell'angolo 'A' e dell'angolo 'B'.

1)

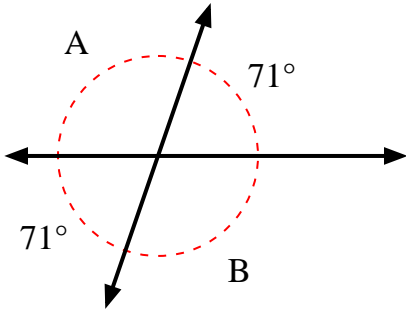

2)

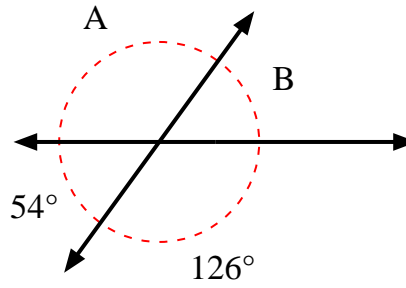

3)

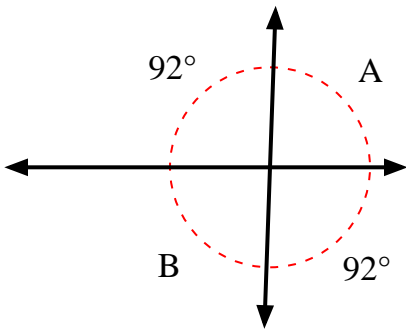

4)

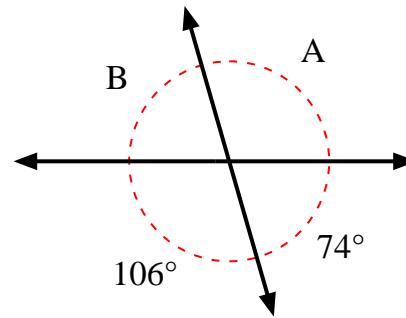

5)

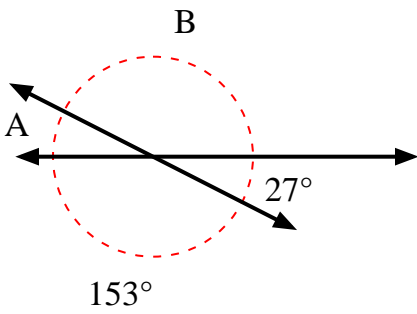

6)

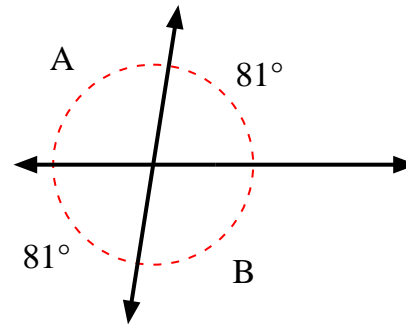

7)

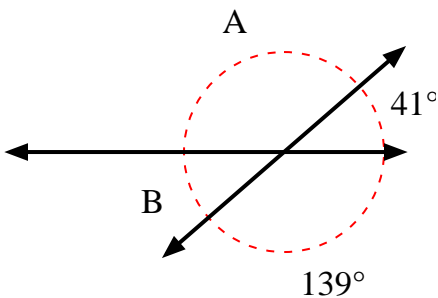

8)

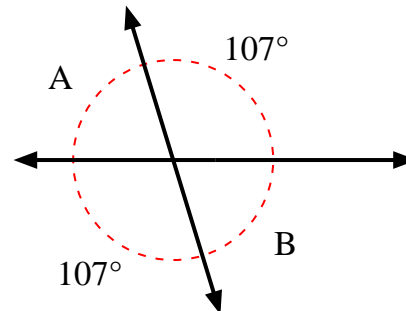

Risposte

1. _____
2. _____
3. _____
4. _____
5. _____
6. _____
7. _____
8. _____



Trova il valore dell'angolo 'A' e dell'angolo 'B'.

1)

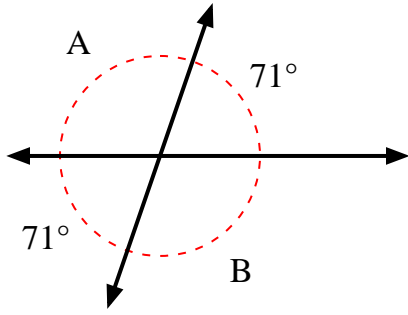

2)

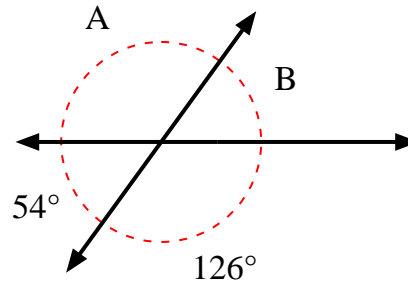

3)

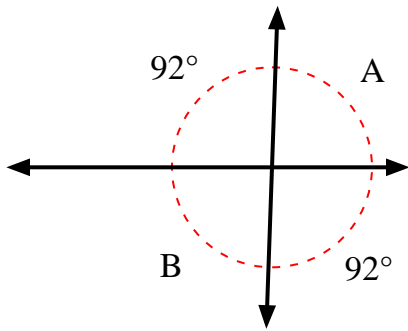

4)

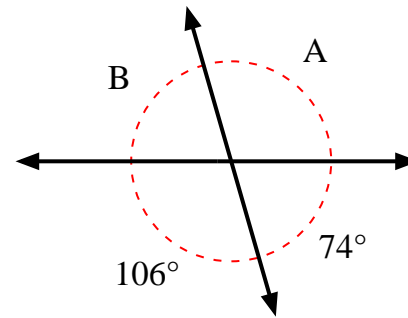

5)

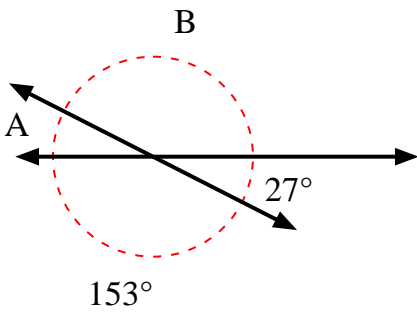

6)

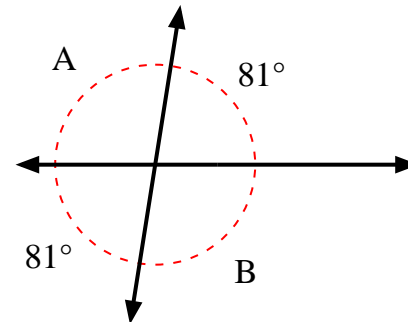

7)

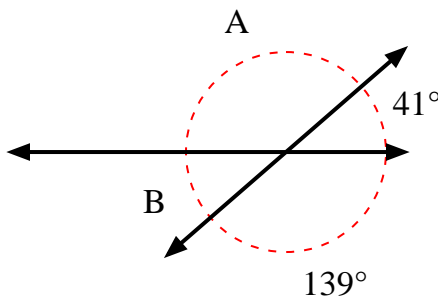

8)

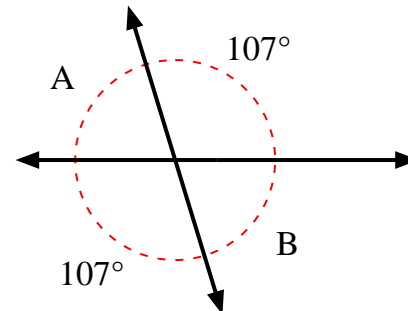
**Risposte**

1.	109°	109°
2.	126°	54°
3.	88°	88°
4.	106°	74°
5.	27°	153°
6.	99°	99°
7.	139°	41°
8.	73°	73°