

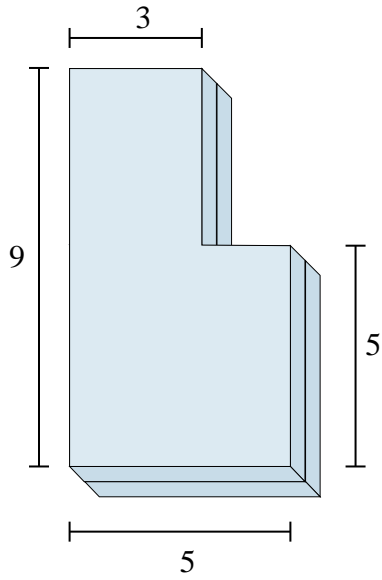

Trova il volume totale di ogni figura.

1)



2)

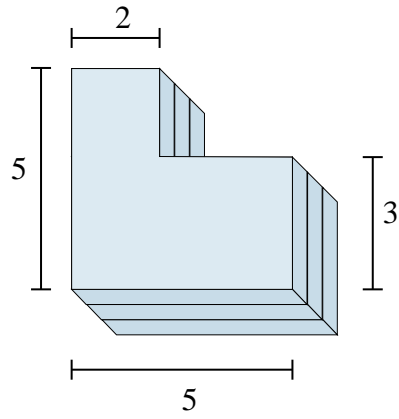

3)

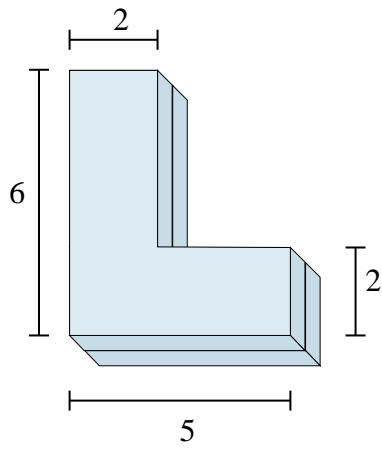

4)

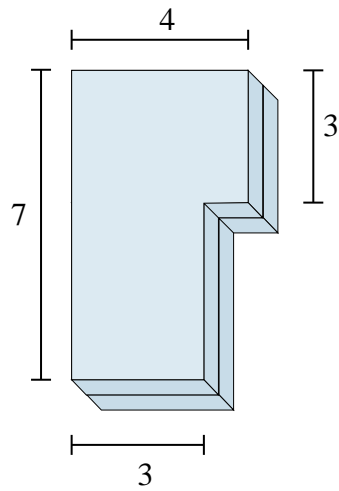

5)

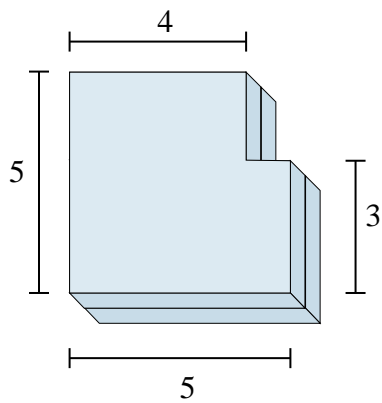

6)

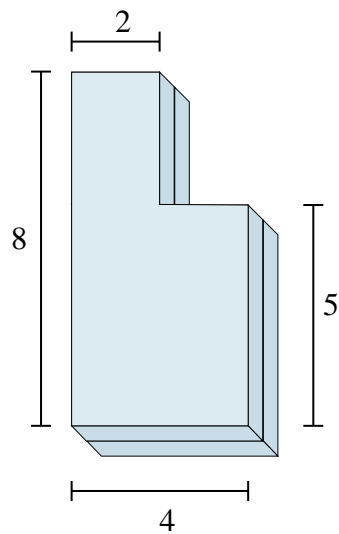

Risposte

1. _____

2. _____

3. _____

4. _____

5. _____

6. _____



Trova il volume totale di ogni figura.

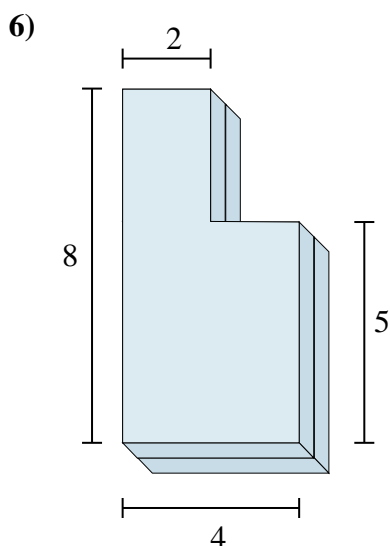
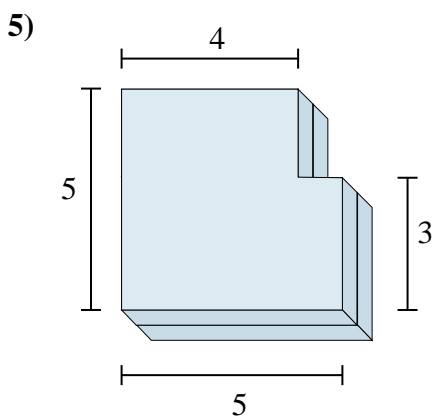
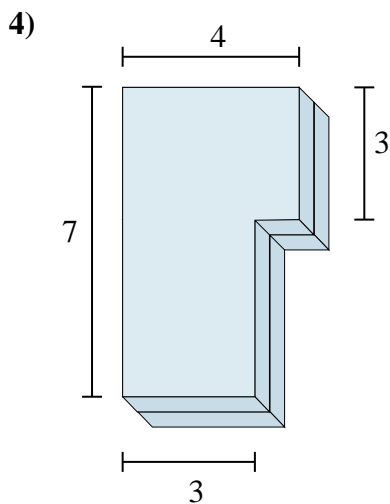
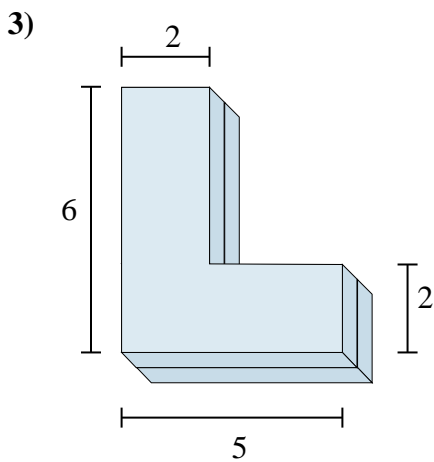
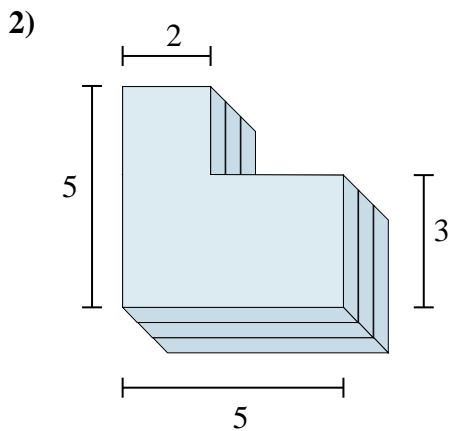
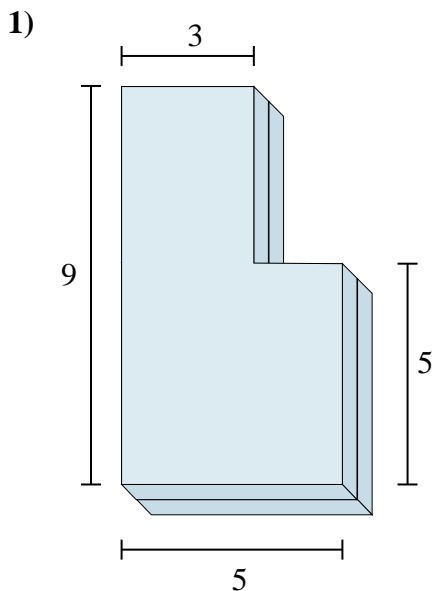

Risposte

1. **74 cm³**

2. **57 cm³**

3. **36 cm³**

4. **48 cm³**

5. **46 cm³**

6. **52 cm³**



Trova il volume totale di ogni figura.

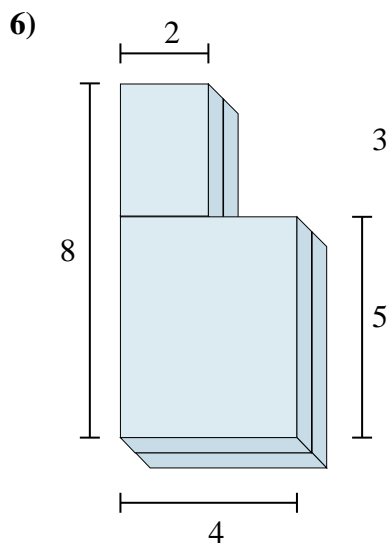
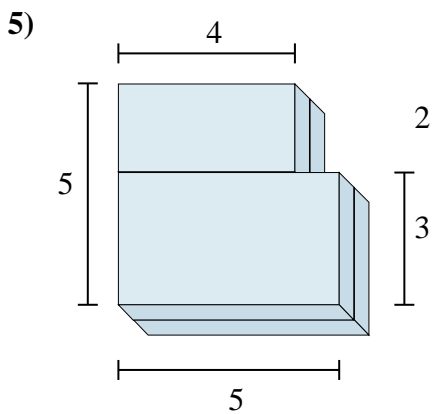
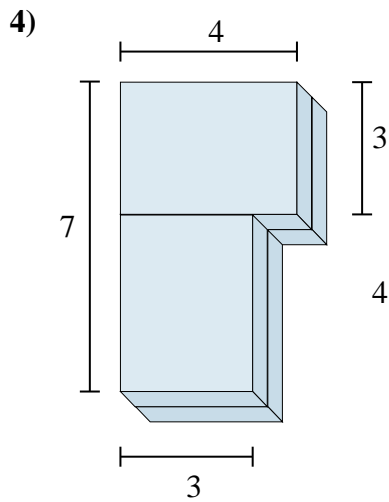
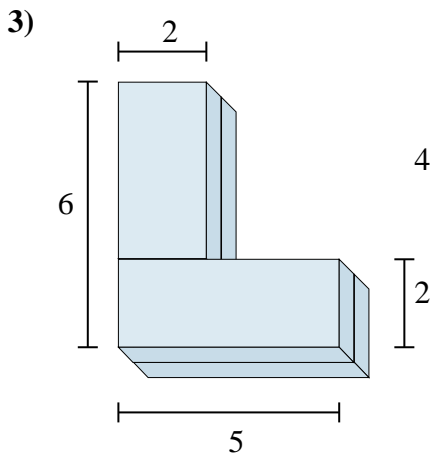
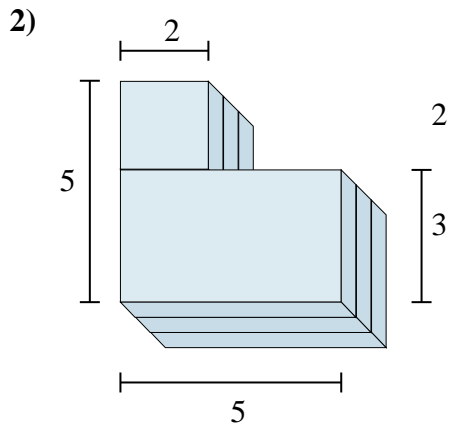
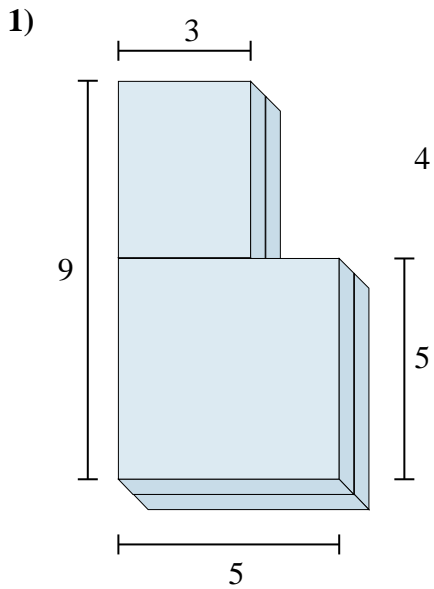

Risposte

1. _____
2. _____
3. _____
4. _____
5. _____
6. _____