

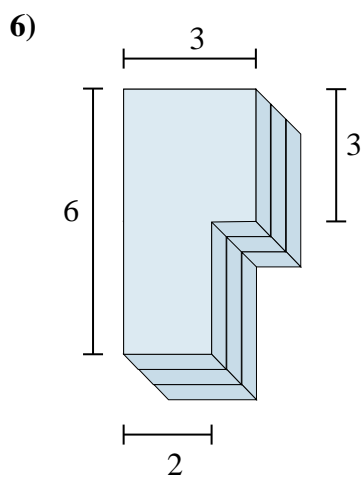

Trova il volume totale di ogni figura.

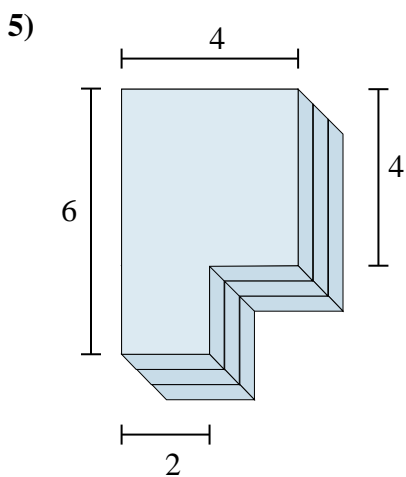
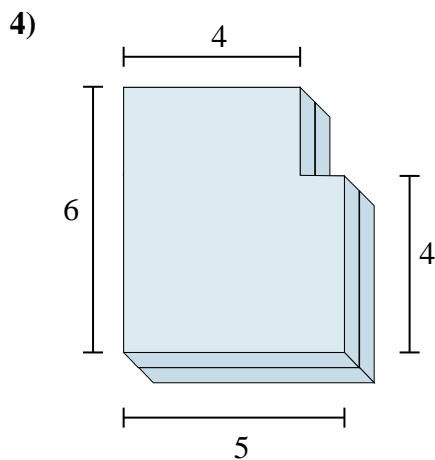
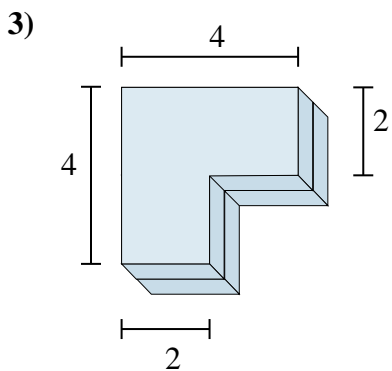
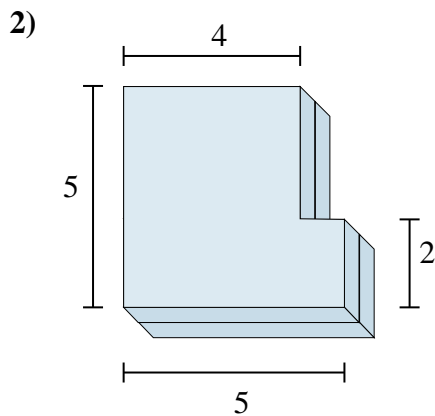
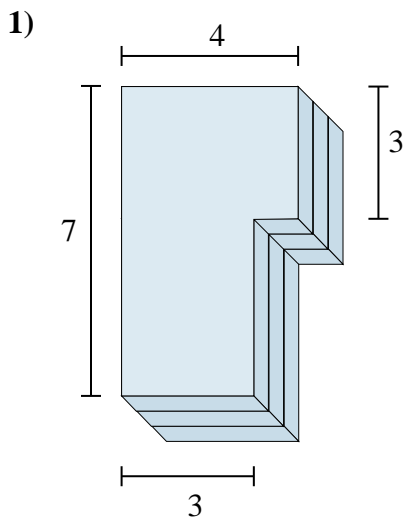

Risposte

- 1. _____
- 2. _____
- 3. _____
- 4. _____
- 5. _____
- 6. _____



Trova il volume totale di ogni figura.

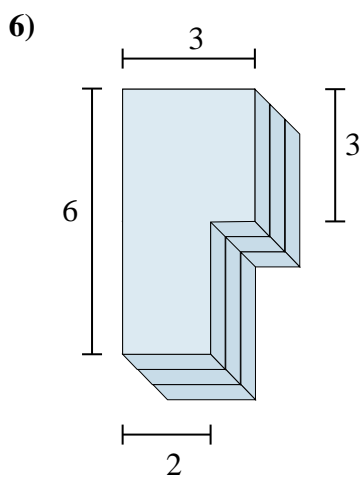
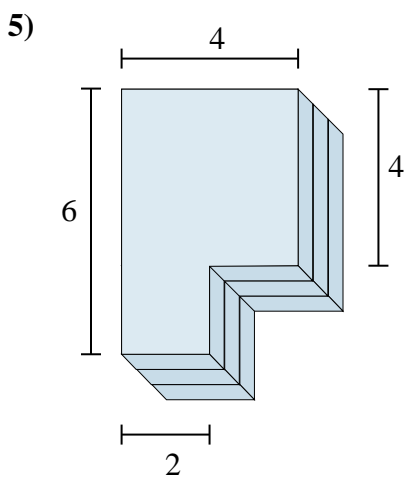
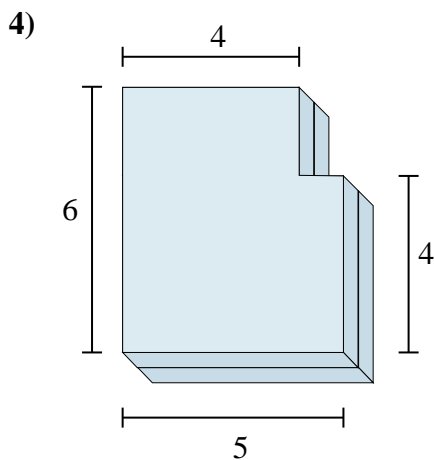
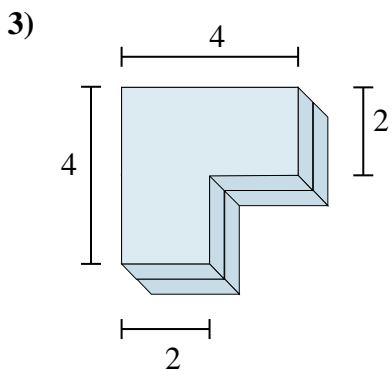
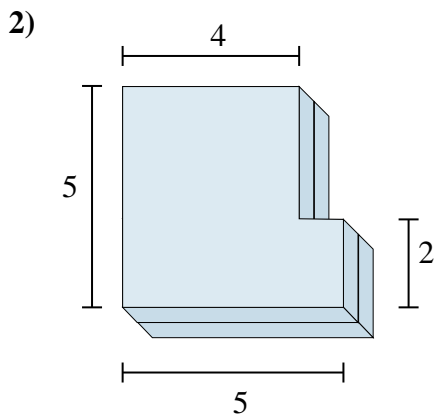
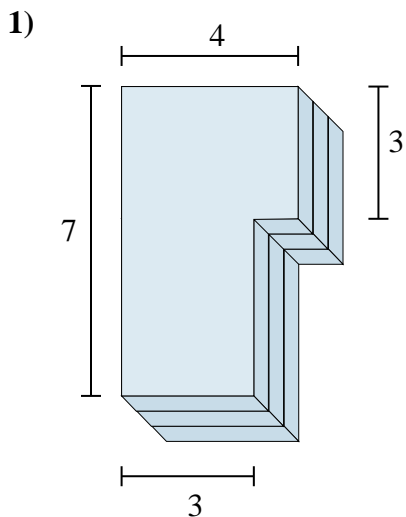

Risposte

1. 72 cm³
2. 44 cm³
3. 24 cm³
4. 56 cm³
5. 60 cm³
6. 45 cm³



Trova il volume totale di ogni figura.

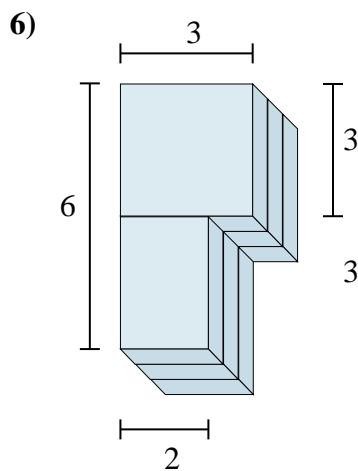
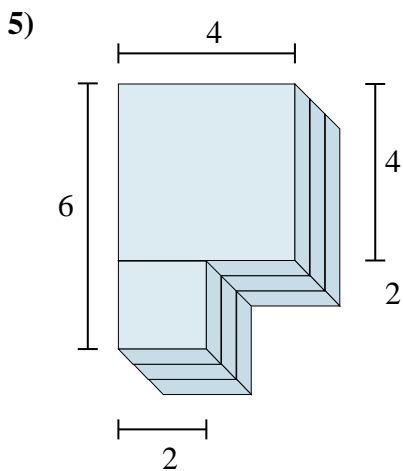
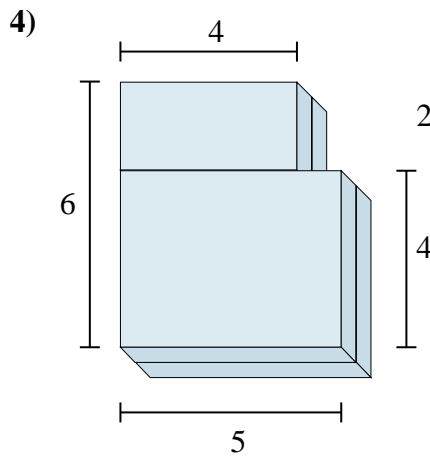
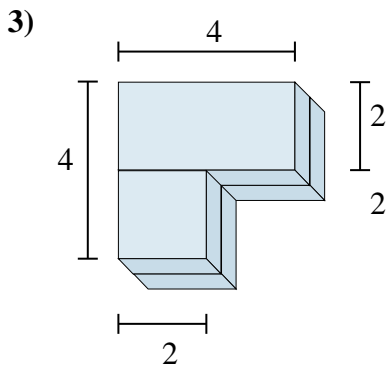
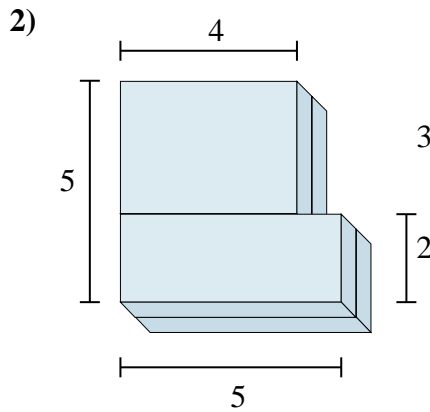
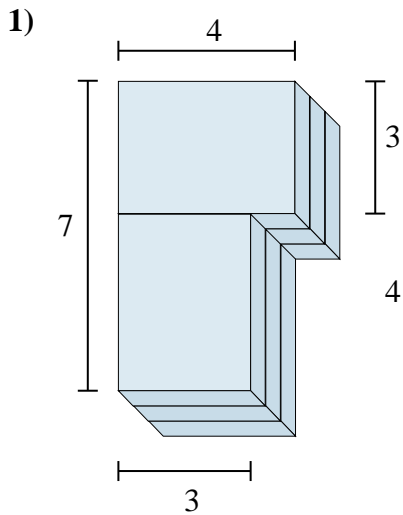

Risposte

1. _____
2. _____
3. _____
4. _____
5. _____
6. _____